

TFS3

series



Product Segments

- **Care Motion**

Maximum available buttons

2

IP rating

Up to IP66

Options

Back up battery or cable less control





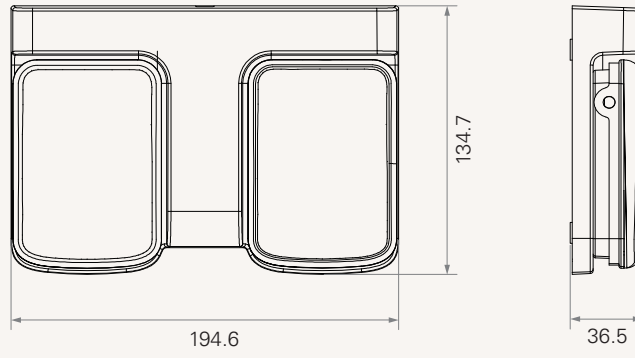



Drawing

Standard Dimensions
(mm)



TFS3

Version: 20150512-B

	Connection	0 = Cableless (frequency : 2.4G)	1 = Cable (standard 1500mm)
	Plug	0 = Wireless version : without plug 1 = DIN 8pin 90° plug 2 = RJ 10pin 90° plug	4 = DIN 8pin 180° plug 5 = RJ 10pin 180° plug, work with TC6/TC9 or extension cable 6 = RJ 10pin 180° plug, work with TC11/TC15/TC16
	Color	1 = Black (Note : There is no indicator light when choosing cableless version)	2 = Grey (Panton 428C) 3 = Standard: upper cover is white, keypad is Panton 428C
	Key Definition	1 = Left key:extend, right key: retract	2 = Left key: retract, right key: extend
	Port Connection to The Control Box (for Motors)	1 = 1 2 = 2 3 = 3	4 = 4 5 = 5 6 = 6 A = Simultaneous or synchronized (Note : it needs to indicate which motor you want to control)
	Backup Battery	0 = Without (cable) 1 = 1.5V AAA dry-cellx2pcs (cableless)	2 = Without battery (cableless)
	IP Rating	0 = Without 1 = IP54	2 = IP66
	Control Box Type	0 = Without MCU	1 = With MCU

Terms of Use

The user is responsible for determining the suitability of TiMOTION products for a specific application. TiMOTION products are subject to change without prior notice.