

Motor cables (motor-driver)

All dimensions are in mm

MSME motors 50–750W	MFMCA0□□0WJD	
MSME motors 1–2kW MDME motors 1–2kW MHME motors 1–11.5kW	MFMCD0□□2GCD	
MHME motors 2kW	MFMCE0□□2GCD	
MSME motors 3–5kW MDME motors 3–5kW MHME motors 3–5kW	MFMCA0□□2GCT	
MSME motors 1–2kW 200V with holding brake MDME motors 1–2kW 200V with holding brake	MFMCA0□□2HCD	
MSME motors 1–2kW 400V with holding brake MDME motors 1–2kW 400V with holding brake MHME motors 1–2kW 400V with holding brake	MFMCE0□□2HCD	
MSME motors 3–5kW with holding brake MDME motors 3–5kW with holding brake MHME motors 3–5kW with holding brake	MFMCA0□□2HCT	
MSMD motors 50–750W MHMD motors 200–750W MINAS LIQI motors 50W–1kW	MFMCA0□□□EEL	

□□ = Length

1□ = 1m

5□ = 5m

Brake cable (motor–driver)

All dimensions are in mm

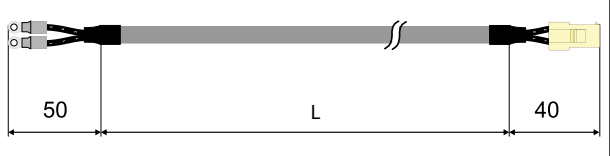
MSME motors 50–750W	MFMCB0□□0PJT	
MSMD motors 50–750W MHMD motors 200–750W MINAS LIQI motors 50W–1kW	MFMCB0□□0GET	

Encoder cable (motor–driver)

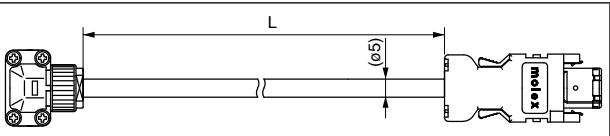
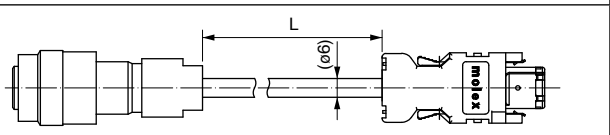
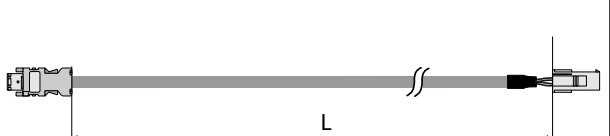
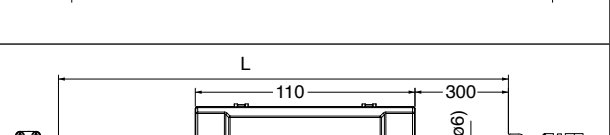
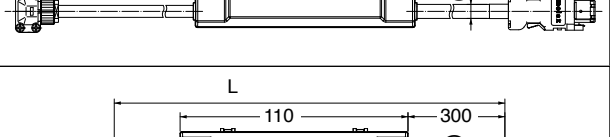
MSME motors 50–750W with 17/20-bit incremental encoder	MFECA□□0WJD	
MSME, MDME, MHME motors 900W–15kW with 17/20-bit incremental encoder	MFECA□□0GTD	
MINAS LIQI motors 50W–1kW MHMD motors 200W–750W	MFECA□□0EAM	
MSME motors 50–750W with 17-bit absolute encoder and battery box	MFECA□□0GJE	
MSME, MDME, MHME motors 900W–15kW with 17-bit absolute encoder and battery box	MFECA□□0GTE	

□□ = Length 10 = 1m 50 = 5m

Control cable (PLC–MINAS LIQI driver)

Direct connection to FP series PLCs

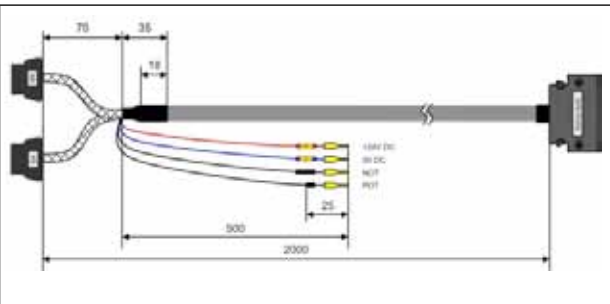
FPΣ (Sigma), FP0R	For 1 axis DV0P0800T01	
-------------------	---------------------------	--

Control cable (PLC-MINAS A5 driver)

All dimensions are in mm

Direct connection to FP series PLCs

<p>FPΣ (Sigma)</p>	<p>For 1 axis DV0P0980W-1 (NPN types) DV0P0982W-1 (PNP types)</p>	
<p>FPΣ (Sigma), FP0R</p> <p>PLC input</p> <p>PLC output</p>	<p>For 1 axis DV0P0988W-1 (PNP types) DV0P0989W-1 (NPN types)</p>	
<p>FPΣ (Sigma)</p>	<p>For 2 axes DV0P0981W-1 (NPN types) DV0P0983W-1 (PNP types)</p>	
<p>FPΣ (Sigma) Positioning unit</p> <p>FP2SH Positioning units</p>	<p>For 2 axes DV0P0985W1 (transistor) DV0P0986W1 (line driver)</p>	
<p>FPΣ (Sigma) Positioning unit</p>	<p>For 1 axis DV0P0800T01 (PNP types)</p>	